



LVTTL/TTL/CMOS-to-Differential LVECL/ ECL Translators

MAX9360/MAX9361

General Description

The MAX9360/MAX9361 are low-skew, single LVTTL/TTL/CMOS-to-differential LVECL/ECL translators designed for high-speed signal and clock driver applications. For interfacing to LVTTL/TTL/CMOS input signals, these devices operate over a 3.0V to 5.5V supply range, allowing high-performance clock or data distribution. For interfacing to differential LVECL/ECL output signals, these devices operate from a -2.375V to -5.5V supply.

The MAX9360 is a 3.3V LVTTL/CMOS-to-LVECL/ECL translator that operates at a typical speed of 3GHz. The MAX9361 is a 5V TTL/CMOS-to-LVECL/ECL translator that operates at a typical speed of 1.3GHz. Both devices can be used to drive either LVECL devices or standard ECL devices with a negative supply range of -2.375V to -5.5V.

The devices default to high if the input is disconnected, and feature ultra-low propagation delay: 440ps for the MAX9360, 810ps for the MAX9361.

The MAX9360 is specified for operation from -40°C to +85°C in an 8-pin SO package, and 0°C to +85°C in a space-saving, 8-pin SOT23 package.

The MAX9361 is specified for operation from -40°C to +85°C for both 8-pin SO and SOT23 packages.

Applications

Clock/Data-Level Translation

Features

- ◆ Output High with Input Open
- ◆ -2.375V to -5.5V LVECL/ECL Operation
- ◆ ESD Protection >2kV (Human Body Model)
- ◆ 3.0V to 3.6V LVTTL/CMOS Operation (MAX9360)
 - Improved Second Source of the MC100EPT24
 - Low 13.8mA (typ) I_{EE} Supply Current
 - 440ps (typ) Propagation Delay
 - >300mV Output at 1GHz
- ◆ 4.5V to 5.5V TTL Operation (MAX9361)
 - Improved Second Source of the MC100ELT24
 - Low 6.6mA (typ) I_{EE} Supply Current
 - 600ps (typ) Propagation Delay
 - >300mV Output at 250MHz

Ordering Information

| PART | TEMP RANGE | PIN-PACKAGE | TOP MARK |
|--------------|----------------|-------------|----------|
| MAX9360EKA-T | -40°C to +85°C | 8 SOT23-8 | AAJI |
| MAX9360ESA | -40°C to +85°C | 8 SO | — |
| MAX9361EKA-T | -40°C to +85°C | 8 SOT23-8 | AAJJ |
| MAX9361ESA | -40°C to +85°C | 8 SO | — |

Pin Configurations

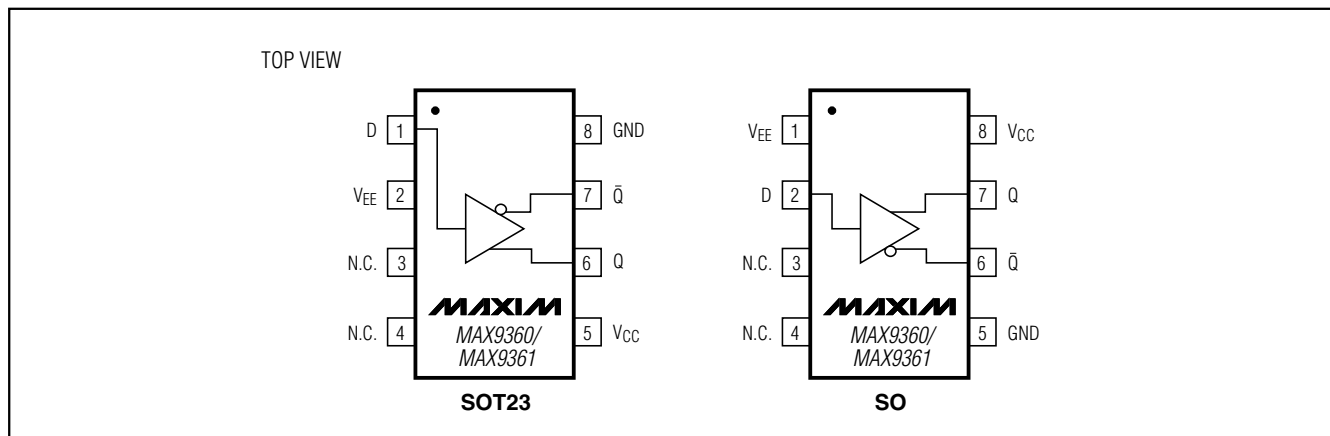

LVTTL/TTL/CMOS-to-Differential LVECL/ECL Translators

ABSOLUTE MAXIMUM RATINGS

| | | | |
|---|-----------------------------------|---|-----------------|
| V _{CC} to GND | -0.3V to +6V | Junction-to-Case Thermal Resistance | |
| V _{EE} to GND..... | -6V to +0.3V | 8-Pin SOT23..... | +80°C/W |
| D to GND..... | -0.3V to (V _{CC} + 0.3V) | 8-Pin SO..... | +40°C/mW |
| Continuous Output Current | 50mA | Continuous Power Dissipation (T _A = +70°C) | |
| Surge Output Current..... | 100mA | 8-Pin SOT23 (derate 8.9mW/°C above +70°C)..... | 714mW |
| Junction-to-Ambient Thermal Resistance in Still Air | | 8-Pin SO (derate 5.9mW/°C above +70°C)..... | 470mW |
| 8-Pin SOT23..... | +112°C/W | Operating Temperature Range | -40°C to +85°C |
| 8-Pin SO..... | +170°C/W | Junction Temperature | +150°C |
| Junction-to-Ambient Thermal Resistance | | Storage Temperature Range | -60°C to +150°C |
| with 500LFPM Airflow | | ESD Protection | |
| 8-Pin SOT23..... | +78°C/W | Human Body Model (D, Q, \bar{Q})..... | >2kV |
| 8-Pin SO..... | +99°C/W | Soldering Temperature (10s)..... | +300°C |

Stresses beyond those listed under "Absolute Maximum Ratings" may cause permanent damage to the device. These are stress ratings only, and functional operation of the device at these or any other conditions beyond those indicated in the operational sections of the specifications is not implied. Exposure to absolute maximum rating conditions for extended periods may affect device reliability.

DC ELECTRICAL CHARACTERISTICS—MAX9360

(V_{CC} = 3.0V to 3.6V, V_{EE} = -2.375V to -5.5V, GND = 0, outputs terminated with 50Ω ±1% to -2.0V. Typical values are at V_{CC} = 3.3V, V_{IH} = 2.0V, V_{IL} = 0.8V, unless otherwise noted.) (Notes 1, 2, 3)

| PARAMETER | SYMBOL | CONDITIONS | 0°C (SOT23) -40°C (SO) | | | +25°C | | | +85°C | | | UNITS |
|--|-----------------------------------|-----------------------------------|---------------------------|------|--------|--------|------|--------|--------|------|--------|-------|
| | | | MIN | TYP | MAX | MIN | TYP | MAX | MIN | TYP | MAX | |
| LVTTL INPUT (D) | | | | | | | | | | | | |
| Input High Current | I _{IH} | V _{IN} = 2.7V | -20 | | +20 | -20 | | +20 | -20 | | +20 | μA |
| | | V _{IN} = V _{CC} | -10 | | +10 | -10 | | +10 | -10 | | +10 | |
| Input Low Current | I _{IL} | V _{IN} = 0.5V | -200 | -51 | | -200 | -60 | | -200 | -67 | | μA |
| Input Clamp Voltage | V _{IK} | I _{IN} = -18mA | -1.2 | | | -1.2 | | | -1.2 | | | V |
| Input High Voltage | V _{IH} | | 2.0 | | | 2.0 | | | 2.0 | | | V |
| Input Low Voltage | V _{IL} | | | | 0.8 | | | 0.8 | | | 0.8 | V |
| LVECL/ECL OUTPUTS (Q, \bar{Q}) | | | | | | | | | | | | |
| Output High Voltage | V _{OH} | | -1.145 | | -0.885 | -1.145 | | -0.885 | -1.145 | | -0.885 | V |
| Output Low Voltage | V _{OL} | | -1.935 | | -1.625 | -1.935 | | -1.625 | -1.935 | | -1.625 | V |
| Differential Output Swing (V _{OH} - V _{OL}) | V _{OH} - V _{OL} | | 550 | | | 550 | | | 550 | | | mV |
| Power-Supply Current | I _{CC} | (Note 4) | | 4.3 | 7.0 | | 5.0 | 7.0 | | 5.6 | 7.0 | mA |
| Internal Chip Current | I _{EE} | (Note 4) | | 12.3 | 20 | | 13.8 | 20 | | 15.2 | 20 | mA |

LVTTTL/TTL/CMOS-to-Differential LVECL/ ECL Translators

DC ELECTRICAL CHARACTERISTICS—MAX9361

($V_{CC} = 4.5V$ to $5.5V$, $V_{EE} = -2.375V$ to $-5.5V$, $GND = 0$, outputs terminated with $50\Omega \pm 1\%$ to $-2.0V$. Typical values are at $V_{CC} = 5V$, $V_{IH} = 2.0V$, $V_{IL} = 0.8V$, unless otherwise noted.) (Notes 1, 2, 3)

| PARAMETER | SYMBOL | CONDITIONS | -40°C (SO) | | | +25°C | | | +85°C | | | UNITS |
|--|-------------------|-------------------|------------|-----|--------|--------|-----|--------|--------|-----|--------|---------|
| | | | MIN | TYP | MAX | MIN | TYP | MAX | MIN | TYP | MAX | |
| TTL INPUT (D) | | | | | | | | | | | | |
| Input High Current | I_{IH} | $V_{IN} = 2.7V$ | -30 | | +30 | -30 | | +30 | -30 | | +30 | μA |
| | | $V_{IN} = V_{CC}$ | -10 | | +10 | -10 | | +10 | -10 | | +10 | |
| Input Low Current | I_{IL} | $V_{IN} = 0.5V$ | -200 | -55 | | -200 | -61 | | -200 | -71 | | μA |
| Input Clamp Voltage | V_{IK} | $I_{IN} = -18mA$ | -1.2 | | | -1.2 | | | -1.2 | | | V |
| Input High Voltage | V_{IH} | | 2.0 | | | 2.0 | | | 2.0 | | | V |
| Input Low Voltage | V_{IL} | | | | 0.8 | | | 0.8 | | | 0.8 | V |
| LVECL/ECL OUTPUTS (Q, \bar{Q}) | | | | | | | | | | | | |
| Output High Voltage | V_{OH} | | -1.055 | | -0.880 | -1.055 | | -0.880 | -1.025 | | -0.880 | V |
| Output Low Voltage | V_{OL} | | -1.875 | | -1.555 | -1.810 | | -1.605 | -1.810 | | -1.605 | V |
| Differential Output Swing ($V_{OH} - V_{OL}$) | $V_{OH} - V_{OL}$ | | 550 | 699 | | 550 | 691 | | 550 | 677 | | mV |
| POWER SUPPLY | | | | | | | | | | | | |
| Power-Supply Current | I_{CC} | (Note 4) | | 3.0 | 7.0 | | 3.5 | 7.0 | | 4.3 | 7.0 | mA |
| Internal Chip Current | I_{EE} | (Note 4) | | 9 | 20 | | 10 | 20 | | 11 | 20 | mA |

MAX9360/MAX9361

LVTTL/TTL/CMOS-to-Differential LVECL/ ECL Translators

AC ELECTRICAL CHARACTERISTICS—MAX9360

($V_{CC} = 3.0V$ to $3.6V$, $V_{EE} = -2.375V$ to $-5.5V$, $GND = 0$, outputs terminated with $50\Omega \pm 1\%$ to $-2.0V$, input frequency = $1.0GHz$, input transition time = $125ps$ (20% to 80%). Typical values are at $V_{CC} = 3.3V$, $V_{IH} = 2.0V$, $V_{IL} = 0.8V$, unless otherwise noted.) (Note 5)

| PARAMETER | SYMBOL | CONDITIONS | 0°C (SOT23) -40°C (SO) | | | +25°C | | | +85°C | | | UNITS |
|-----------------------------------|----------------------------|--|---------------------------|-----|-----|-------|-----|-----|-------|-----|-----|---------|
| | | | MIN | TYP | MAX | MIN | TYP | MAX | MIN | TYP | MAX | |
| Maximum Toggle Frequency | f_{MAX} | $V_{OH} - V_{OL} \geq 300mV$ | 1.0 | 3.0 | | 1.0 | 3.0 | | 1.0 | 3.0 | | GHz |
| | | $V_{OH} - V_{OL} \geq 500mV$ | 0.85 | 1.5 | | 0.85 | 1.5 | | 0.85 | 1.5 | | |
| Input-to-Output Propagation Delay | t_{PLHD} , t_{PHLD} | Figure 1 | 300 | | 800 | 300 | | 800 | 300 | | 800 | ps |
| Output Rise/Fall Time | t_R , t_F | Figure 1 | 70 | 97 | 150 | 80 | 105 | 150 | 100 | 122 | 150 | ps |
| Added Deterministic Jitter | t_{DJ} | 2Gbps 2^{23} - 1 PRBS pattern (Note 6) | | 43 | 70 | | 43 | 70 | | 43 | 70 | ps(P-P) |
| Added Random Jitter | t_{RJ} | 1.0GHz clock pattern (Note 6) | | 1.4 | 3.0 | | 1.5 | 3.0 | | 1.5 | 3.0 | ps(RMS) |

AC ELECTRICAL CHARACTERISTICS—MAX9361

($V_{CC} = 4.5V$ to $5.5V$, $V_{EE} = -2.375V$ to $-5.5V$, $GND = 0$, outputs terminated with $50\Omega \pm 1\%$ to $-2.0V$, input frequency = $100MHz$, input transition time = $125ps$ (20% to 80%). Typical values are at $V_{CC} = 5.0V$, $V_{IH} = 2.0V$, $V_{IL} = 0.8V$, unless otherwise noted.) (Note 5)

| PARAMETER | SYMBOL | CONDITIONS | -40°C | | | +25°C | | | +85°C | | | UNITS |
|-----------------------------------|----------------------------|--|-------|------|------|-------|------|------|-------|------|------|---------|
| | | | MIN | TYP | MAX | MIN | TYP | MAX | MIN | TYP | MAX | |
| Maximum Toggle Frequency | f_{MAX} | $V_{OH} - V_{OL} \geq 300mV$ | 250 | 1300 | | 250 | 1300 | | 250 | 1300 | | MHz |
| | | $V_{OH} - V_{OL} \geq 500mV$ | 150 | 500 | | 150 | 500 | | 150 | 500 | | |
| Input-to-Output Propagation Delay | t_{PLHD} , t_{PHLD} | Figure 1 | 300 | 561 | 900 | 300 | 583 | 900 | 300 | 607 | 900 | ps |
| Output Rise/Fall Time | t_R , t_F | Figure 1 | 250 | 340 | 1000 | 250 | 342 | 1000 | 250 | 353 | 1000 | ps |
| Added Deterministic Jitter | t_{DJ} | 200Mbps 2^{23} - 1 PRBS pattern (Note 6) | | 81 | 150 | | 83 | 150 | | 85 | 150 | ps(P-P) |
| Added Random Jitter | t_{RJ} | 100MHz clock pattern (Note 6) | | 4 | 10 | | 4 | 10 | | 4 | 10 | ps(RMS) |

Note 1: Measurements are made with the device in thermal equilibrium.

Note 2: Current into a pin is defined as positive. Current out of a pin is defined as negative.

Note 3: DC parameters are production tested at +25°C. DC limits are guaranteed by design and characterization over the full operating temperature range.

Note 4: All pins are open except V_{CC} , V_{EE} , and GND .

Note 5: Guaranteed by design and characterization. Limits are set to ± 6 sigma.

Note 6: Device jitter added to the input signal.

LVTTL/TTL/CMOS-to-Differential LVECL/ ECL Translators

Typical Operating Characteristics

(MAX9360: $V_{CC} = 3.3V$ and $V_{EE} = -5V$, $V_{IH} = 2.0V$, $V_{IL} = 0.8V$, $T_A = +25^\circ C$, outputs terminated with 50Ω to $-2V$, input frequency = $1GHz$, input transition time = $125ps$ (20% to 80%), unless otherwise noted.)

MAX9360/MAX9361

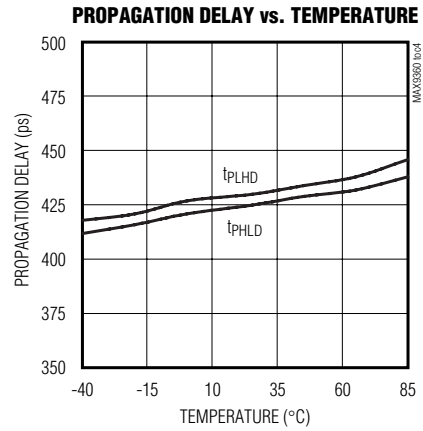
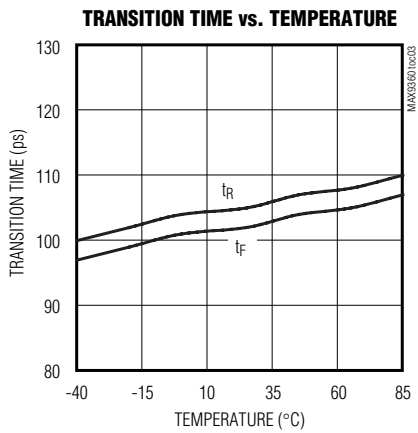
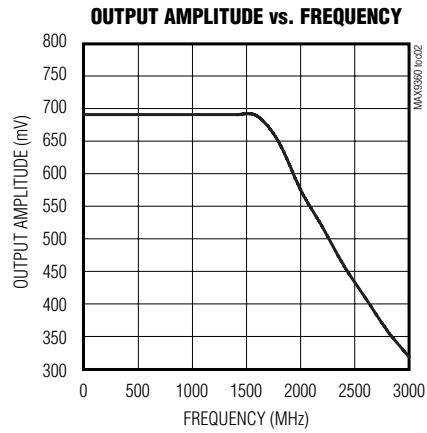
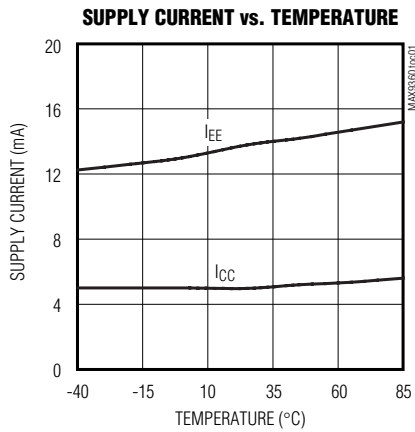

LVTTL/TTL/CMOS-to-Differential LVECL/ECL Translators

Pin Description

| PIN | | NAME | FUNCTION |
|------|-------|-----------------|--|
| SO | SOT23 | | |
| 1 | 2 | V _{EE} | Negative Supply Voltage. Bypass V _{EE} to GND with 0.1μF and 0.01μF ceramic capacitors. Place the capacitors as close to the device as possible with the smaller value capacitor closest to the device. |
| 2 | 1 | D | LVTTL/CMOS Input for MAX9360. TTL/CMOS input for MAX9361. |
| 3, 4 | 3, 4 | N.C. | No Connect. Connect to GND. |
| 5 | 8 | GND | Ground |
| 6 | 7 | \bar{Q} | Inverting Differential LVECL/ECL Output. Typically terminate with 50Ω resistor to -2V. |
| 7 | 6 | Q | Noninverting Differential LVECL/ECL Output. Typically terminate with 50Ω resistor to -2V. |
| 8 | 5 | V _{CC} | Positive Supply Voltage. Bypass V _{CC} to GND with 0.1μF and 0.01μF ceramic capacitors. Place the capacitors as close to the device as possible with the smaller value capacitor closest to the device. |

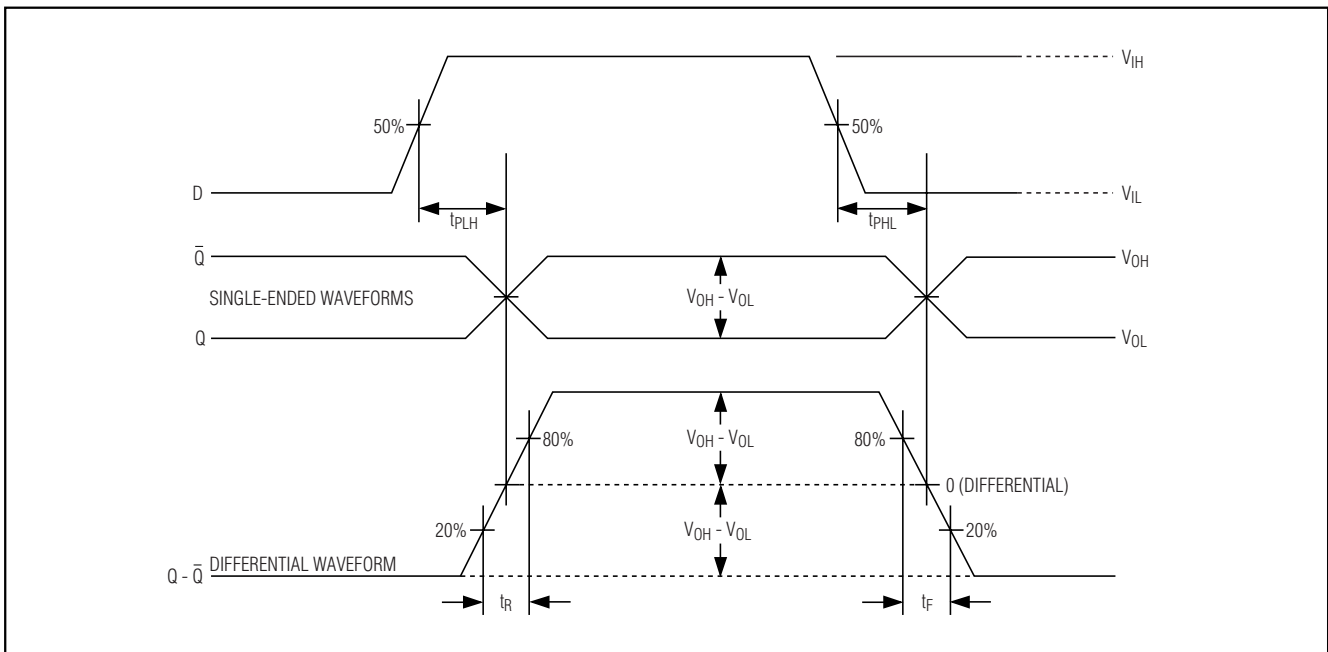

Figure 1. Input-to-Output Propagation Delay and Transition Timing Diagram

LVTTL/TTL/CMOS-to-Differential LVECL/ECL Translators

MAX9360/MAX9361

Detailed Description

The MAX9360/MAX9361 are low-skew, single LVTTL/CMOS/TTL-to-differential LVECL/ECL translators designed for high-speed signal and clock driver applications. For interfacing to LVTTL/TTL/CMOS input signals, these devices operate over a 3.0V to 5.5V supply range, allowing high-performance clock or data distribution in systems with a nominal 3.3V or 5.0V supply. For interfacing to differential LVECL/ECL output signals, these devices operate from a -2.375V to -5.5V supply.

The MAX9360 is a 3.3V LVTTL/CMOS-to-LVECL/ECL translator that operates at typical speeds of 3GHz. The MAX9361 is a 5V TTL/CMOS-to-LVECL/ECL translator that operates at typical speeds of 1.3GHz. Both devices can be used to drive either LVECL devices or standard ECL devices with a negative supply range of -2.375V to -5.5V.

Input

The MAX9360/MAX9361 inputs accept standard LVTTL/TTL/CMOS levels. The input has pullup circuitry that drives the outputs to a differential high if the inputs are open.

Differential Output

Output levels are referenced to GND and are considered ECL or LVECL, depending on the level of the V_{EE} supply. With GND connected to zero and V_{EE} at -4.2V to -5.5V, the outputs are ECL. The outputs are LVECL when GND is connected to zero and V_{EE} is at -2.375V to -3.8V.

Applications Information

Supply Bypassing

Bypass V_{CC} and V_{EE} to ground with high-frequency surface-mount ceramic 0.1 μ F and 0.01 μ F capacitors in parallel as close to the device as possible, with the 0.01 μ F value capacitor closest to the device. Use multiple parallel vias for low inductance.

Traces

Input and output trace characteristics affect the performance of the MAX9360/MAX9361. Connect each signal of a differential output to a 50 Ω characteristic impedance trace. Minimize the number of vias to prevent impedance discontinuities. Reduce reflections by maintaining the 50 Ω characteristic impedance through connectors and across cables. Reduce skew within a differential pair by matching the electrical length of the traces.

On the MAX9360, if the input edge rate approaches the electrical length of the interconnect, then controlled-impedance transmission lines should be used for the input traces.

Output Termination

Terminate outputs through 50 Ω to -2V or use an equivalent Thevenin termination. Terminate both outputs and use the same termination on each for the lowest output-to-output skew. When a single-ended signal is taken from a differential output, terminate both outputs. For example, if Q is used as a single-ended output, terminate both Q and \bar{Q} .

Ensure that the output currents do not exceed the continuous safe output current limit or surge output current limit as specified in the *Absolute Maximum Ratings* table. Under all operating conditions, the device's total thermal limits should be observed.

Chip Information

TRANSISTOR COUNT: 330

PROCESS: Bipolar

LVTTL/TTL/CMOS-to-Differential LVECL/ ECL Translators

Package Information

(The package drawing(s) in this data sheet may not reflect the most current specifications. For the latest package outline information, go to www.maxim-ic.com/packages.)

| SYMBOL | MIN | MAX |
|----------|----------|------|
| A | 0.90 | 1.45 |
| A1 | 0.00 | 0.15 |
| A2 | 0.90 | 1.30 |
| b | 0.28 | 0.45 |
| C | 0.09 | 0.20 |
| D | 2.80 | 3.00 |
| E | 2.60 | 3.00 |
| E1 | 1.50 | 1.75 |
| L | 0.10 | 0.60 |
| e | 0.65 ref | |
| e1 | 1.95 ref | |
| α | 0° | 10° |

NOTE:
 1. ALL DIMENSIONS ARE IN MILLIMETERS.
 2. FOOT LENGTH MEASURED REFERENCE TO FLAT FOOT SURFACE PARALLEL TO DATUM "A".
 3. PACKAGE OUTLINE EXCLUSIVE OF MOLD FLASH & METAL BURR.
 4. PACKAGE OUTLINE INCLUSIVE OF SOLDER PLATING.
 5. EIAJ REF. NUMBER* SC-74 (6 LEAD VERSION)
 6. COPLANARITY 4 MILS. MAX.
 7. PIN 1 I.D. DOT IS 0.3 MM ϕ MIN. LOCATED ABOVE PIN 1.
 8. MEETS JEDEC MO178.

MAXIM
 PROPRIETARY INFORMATION
 TITLE: PACKAGE OUTLINE, SOT-23, 8L
 APPROVAL: _____ DOCUMENT CONTROL NO. 21-0078 REV C 1/1

SOT23, 8LEPS

LVTTL/TTL/CMOS-to-Differential LVECL/ ECL Translators

Package Information (continued)

(The package drawing(s) in this data sheet may not reflect the most current specifications. For the latest package outline information, go to www.maxim-ic.com/packages.)

MAX9360/MAX9361

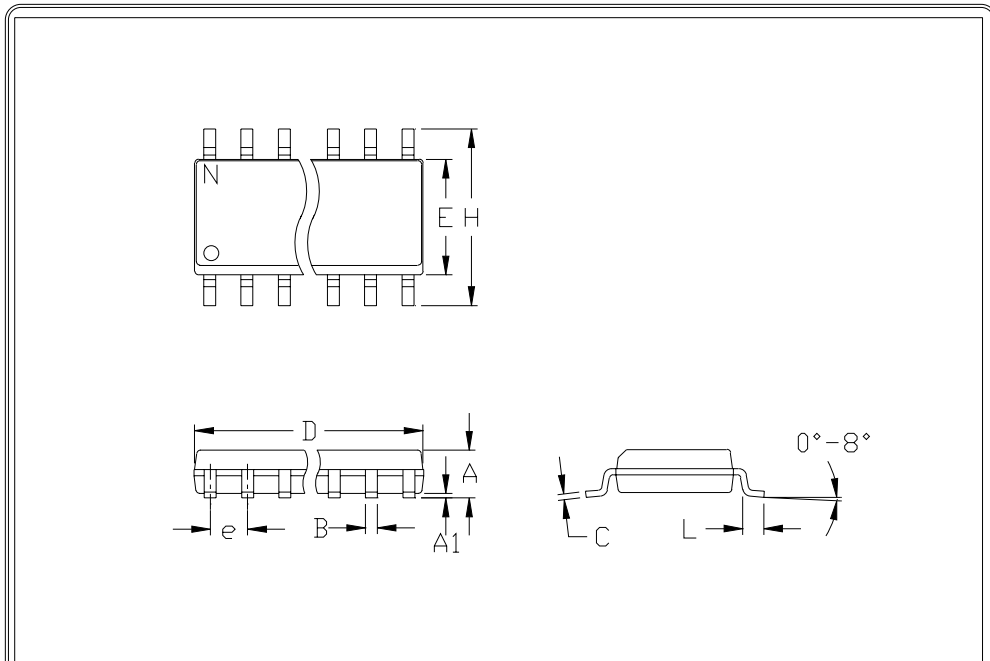

| | INCHES | | MILLIMETERS | |
|----|--------|-------|-------------|------|
| | MIN | MAX | MIN | MAX |
| A | 0.053 | 0.069 | 1.35 | 1.75 |
| A1 | 0.004 | 0.010 | 0.10 | 0.25 |
| B | 0.014 | 0.019 | 0.35 | 0.49 |
| C | 0.007 | 0.010 | 0.19 | 0.25 |
| e | 0.050 | | 1.27 | |
| E | 0.150 | 0.157 | 3.80 | 4.00 |
| H | 0.228 | 0.244 | 5.80 | 6.20 |
| h | 0.010 | 0.020 | 0.25 | 0.50 |
| L | 0.016 | 0.050 | 0.40 | 1.27 |

| | INCHES | | MILLIMETERS | | N | MS012 |
|---|--------|-------|-------------|-------|----|-------|
| | MIN | MAX | MIN | MAX | | |
| D | 0.189 | 0.197 | 4.80 | 5.00 | 8 | A |
| D | 0.337 | 0.344 | 8.55 | 8.75 | 14 | B |
| D | 0.386 | 0.394 | 9.80 | 10.00 | 16 | C |

NOTES:

1. D&E DO NOT INCLUDE MOLD FLASH
2. MOLD FLASH OR PROTRUSIONS NOT TO EXCEED .15mm (.006")
3. LEADS TO BE COPLANAR WITHIN .102mm (.004")
4. CONTROLLING DIMENSION: MILLIMETER
5. MEETS JEDEC MS012-XX AS SHOWN IN ABOVE TABLE
6. N = NUMBER OF PINS

| | | | |
|---|------------------------------------|--|--|
| <small>120 SAN GABRIEL DR. SUNNYVALE, CA 94086 FAX (408) 737-7594</small> <small>PROPRIETARY INFORMATION</small> | PACKAGE FAMILY OUTLINE: SOIC .150" | | 21-0041 A |
| | | | <small>DOCUMENT CONTROL NUMBER REV</small> |

Maxim cannot assume responsibility for use of any circuitry other than circuitry entirely embodied in a Maxim product. No circuit patent licenses are implied. Maxim reserves the right to change the circuitry and specifications without notice at any time.

Maxim Integrated Products, 120 San Gabriel Drive, Sunnyvale, CA 94086 408-737-7600 _____ 9